

表面

QFP64/0.5

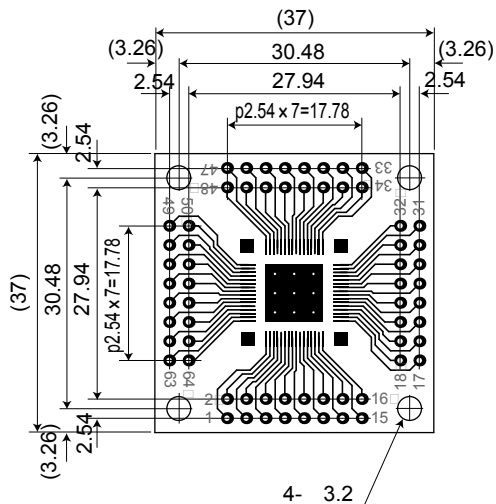

裏面

QFP64/0.8

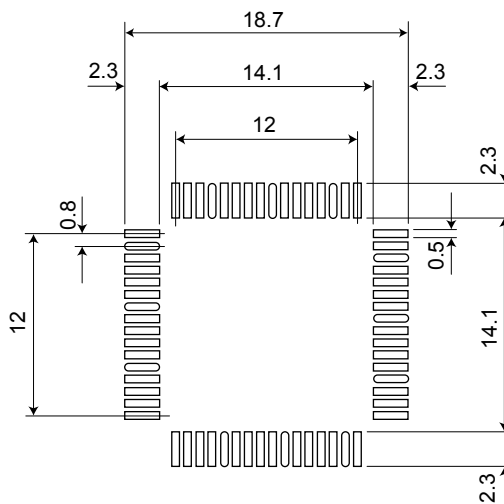
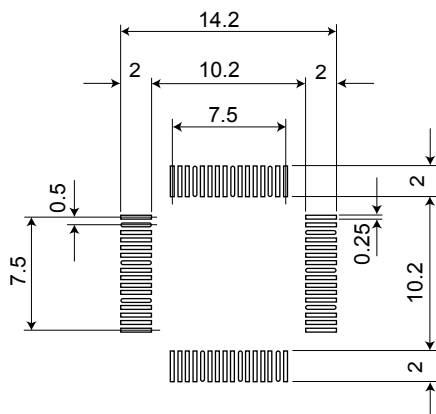
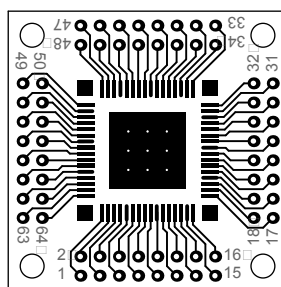

品名	QFP変換基板		処理			
型名	Q064		図番	#080905-02	縮尺	2 : 1
材質	FR-4 (ガラエポ)	両面スルー	作成日	2008/09/05		
寸法	37 x 37 (mm)	板厚	1.0 t	株式会社ダイセン電子工業		